

Drehstrommotor / Three-Phase Motor

IE3 - 22 kW - 4 polig / 4 pole - B3

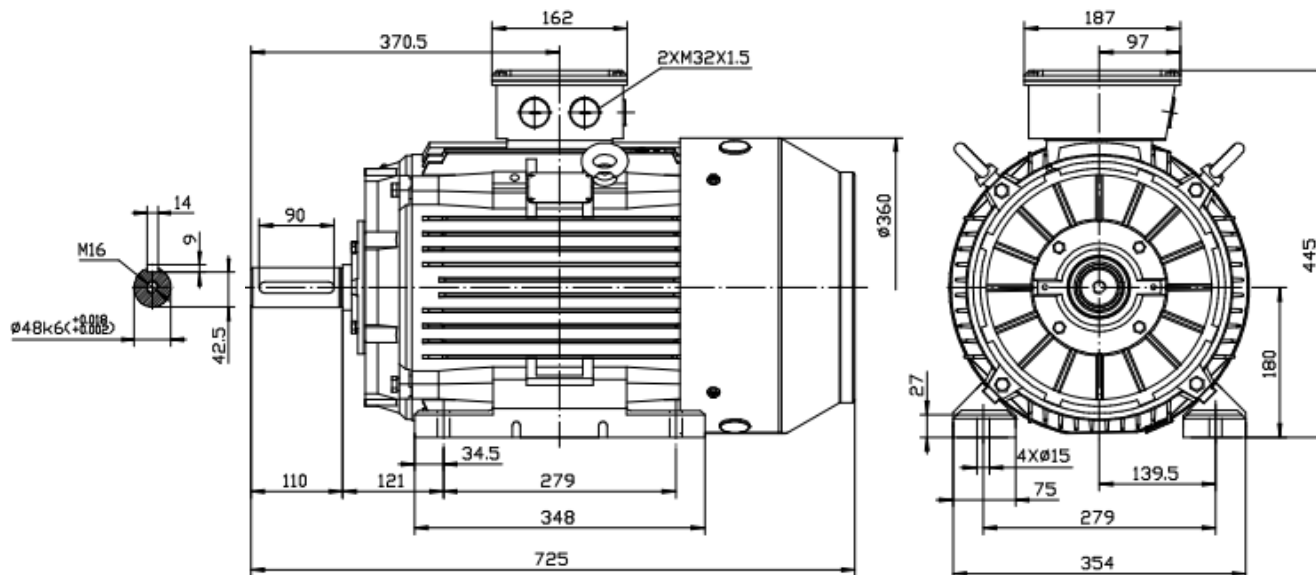

Typ / type

IE3 SEV- 180L-4

Gehäusematerial / frame material		Grauguss / cast iron
Ausführung / execution		Dreiphasen/ three phase
Baugröße / frame size		180
Leistung / power @50Hz	kW	22,00
Nennstrom / rated current @400V	Δ	39,25
Nennstrom / rated current @690V	Y	22,75
Drehzahl / speed @50Hz	Upm / rpm	1460
Wirkungsgrad / efficiency	IE3	
	Eff.100%	93,00
	Eff.75%	93,7
	Eff.50%	92,90
Leistungsfaktor / power factor cosφ	Last / load 100%	0,87
60Hz 460/793V	Power(kW)	25,30
60Hz 480/830V	Power(kW)	26,40
Drehzahl / speed @60Hz	(r/min)	1752
Normen / regulations		IEC / DIN / ISO / VDE / EN
Standard / standard		IEC 60034
Umgebungstemperatur / ambient Temp.		-20°C ~ +40°C
Aufstellungshöhe / altitude (max.)		1000m über Meeresspiegel / above sea level

Nenn Drehmoment / rated torque	143,90
Anzugs- zu Nennmoment / start- to rated torque	2,5
Kipp- zu Nennmoment / brakedown- to rated torque	3
min. Dreh- zu Nennmoment / min- to rated torque	1,8
Anzugs- zu Nennstrom / starting- to rated current	10
Lager / bearing (DE)	6311C3
Lager / bearing (NDE)	6311C3
Wellendichtung / shaft seal (DE/NDE)	55*75*8
Hauptkabelverschraubung / main cable glands	2-M32*1.5
Isolationsklasse / insulation class	F
Schutzart / protection degree	IP 55
Thermischer Schutz / thermal protection	3*PTC
Drehrichtung / rotation direction	rechts-links / clockwise-counterclockwise
Einschaltdauer / service duty	S1
Wuchtung / balance	Halbkeilwuchtung / half-key balanced
Kühlungsart / cooling	IC 411
Lautstärke / noise dB(A)	76
Nettogewicht / net weight(kg)	176,00
Massenträgheitsmoment / moment of inertia (kg*m ²)	0,194330000